

SPOT
INTILED



SPOT is the new version of IntiSPOT accent luminaire. Fresh design + all latest INTILED technologies onboard = perfect flexible tool for various accent lighting applications.



SPOT

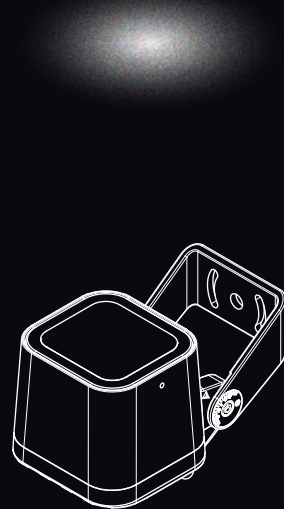

KUB

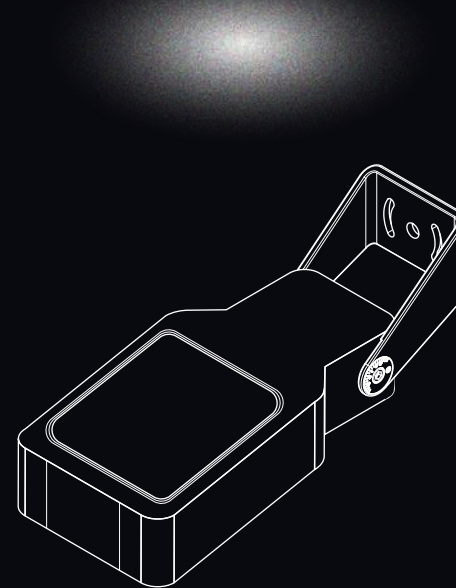

RAY

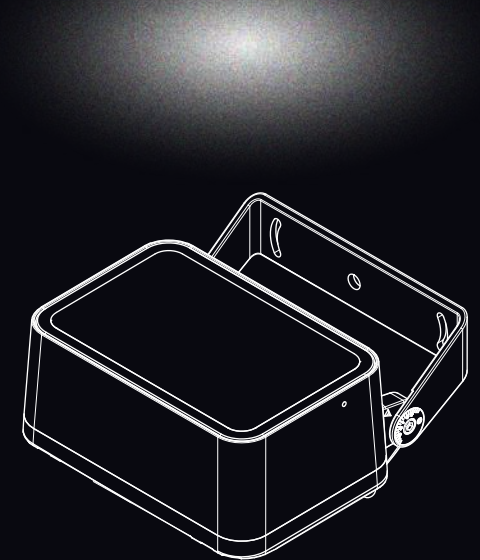

BOX

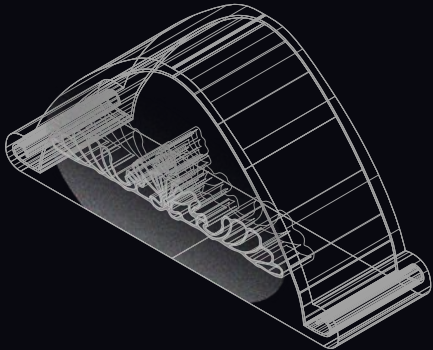
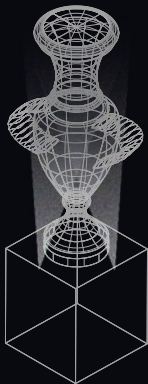
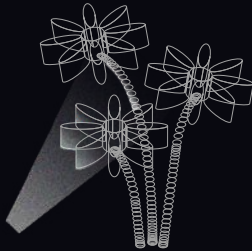
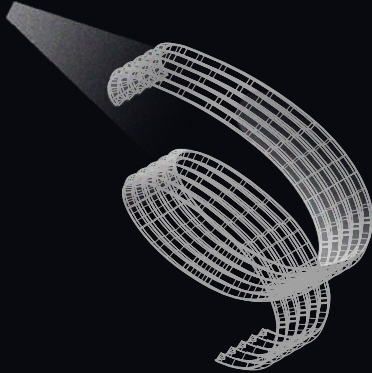
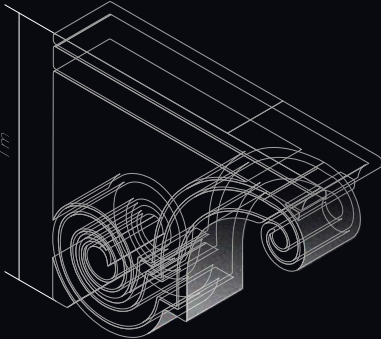
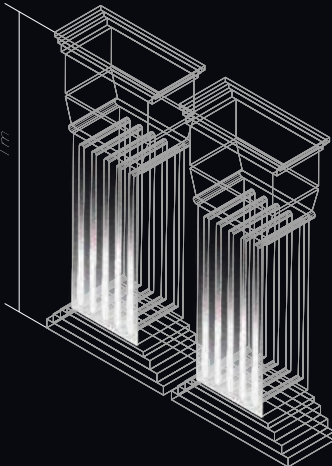
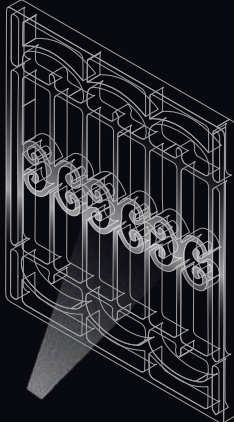
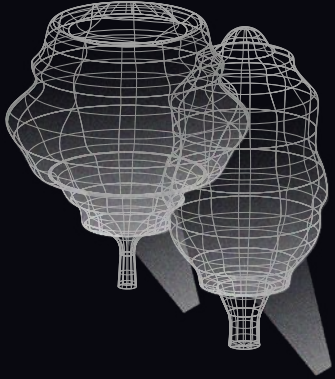
	Architectural lighting	Landscape lighting
Accent lighting	<p>mascaron 40°, 120°</p>  <p>vase 15x60°, 120°</p> 	<p>small plants 15°, 30°, 40°</p>  <p>small architectural form 30°, 40°</p> 
Flood lighting	<p>console 30°, 40°, 120°</p>  <p>pilasters 15°, 30°</p> 	<p>trellis 15°, 15x60°</p>  <p>small bushes 40°, 120°</p> 

SPOT TECHNICAL SPECIFICATION

I N T I L E D

Light color	white (3000 K, 4000 K, 5000 K)
Lumen output	up to 330 lm
Control	PWM
Voltage	24 V DC
Optics	15°, 15x60°, 30°, 40°, 120°
Protection class	IP66
Mechanical resistance	IK08
Operating temperature	-40°C ... +55°C
Lifespan	not less than 50 000 hours
Dimensions	97x70x90 mm – without bracket 143x69x110 mm – with bracket
Weight	0,6 kg
Materials	housing, bracket – die cast aluminum; diffusor – tempered glass
Contents of delivery	luminaire, passport, package

SPOT MODEL RANGE

I N T I L E D

15°



30°



40°



15x60°



120°



SPOT MODEL RANGE. ILLUMINANCE

I N T I L E D

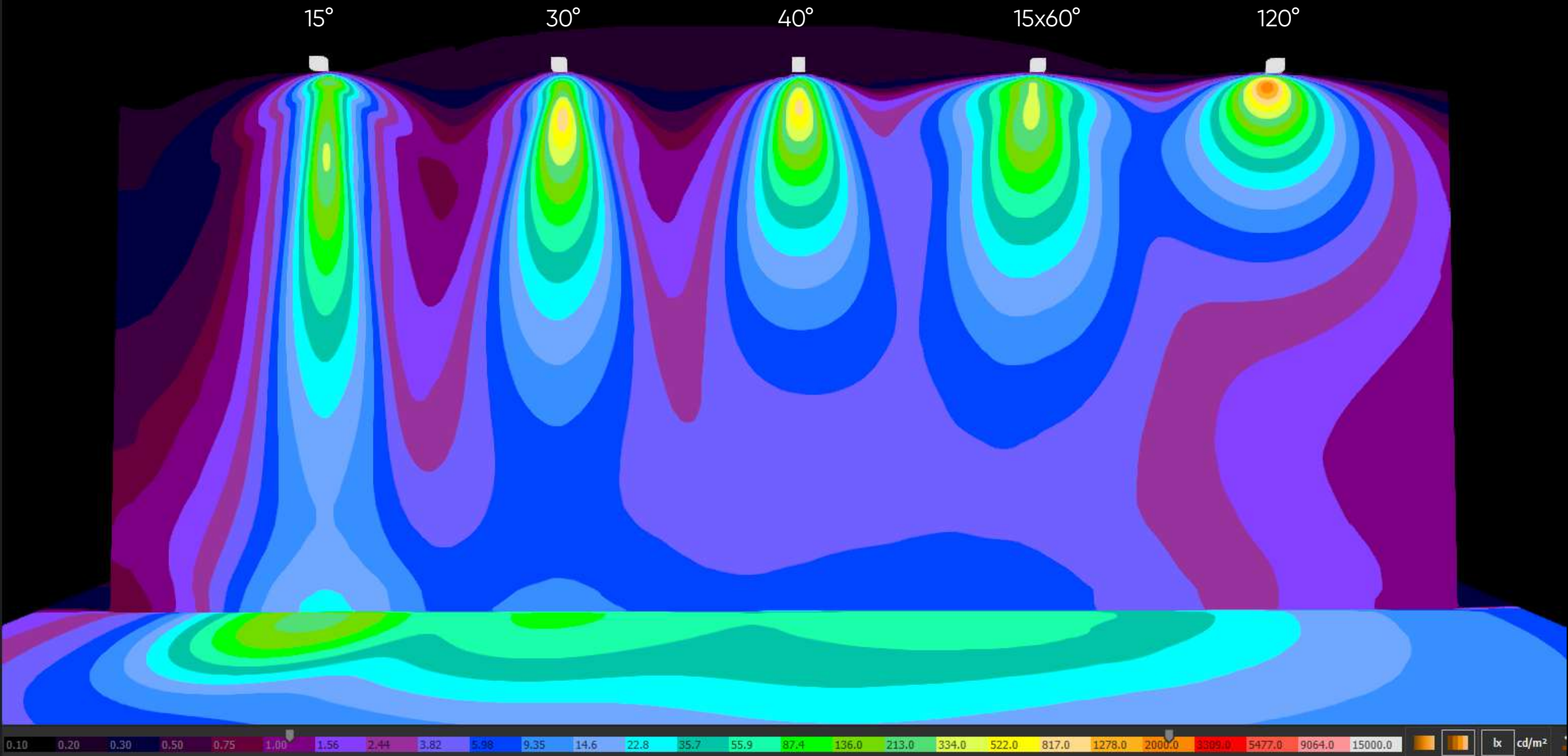

SPOT MODEL RANGE. LUMINANCE

I N T I L E D

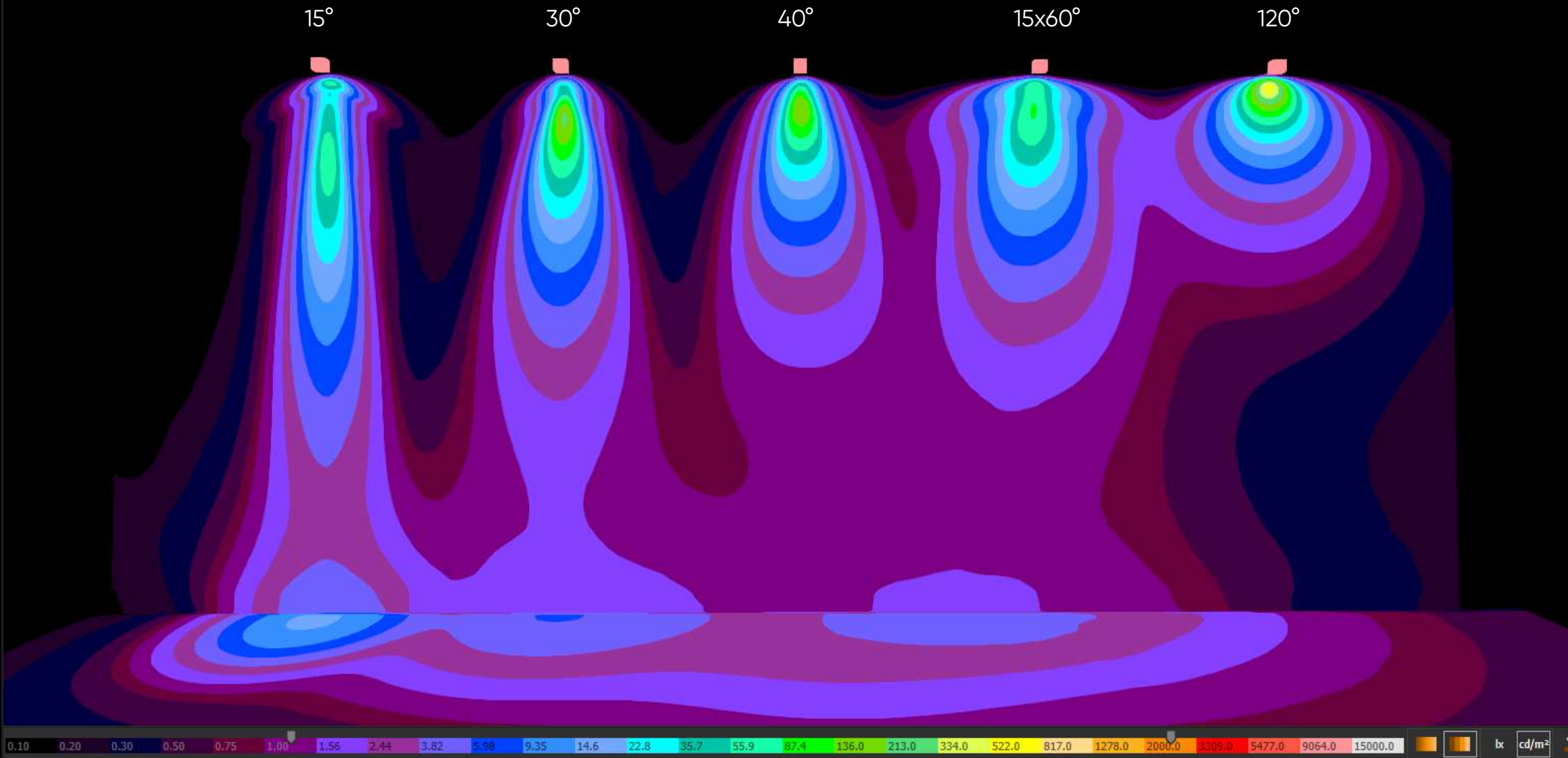

15°

30°

40°

15x60°

120°

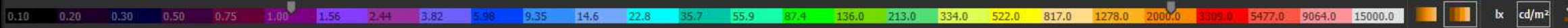

COMPARISON BETWEEN DIFFERENT SERIES OF PRODUCTS

I N T I L E D

SPOT
30°



IntiSPOT
24°



KUB
30°



RAY
30°



COMPARISON BETWEEN DIFFERENT SERIES OF PRODUCTS. ILLUMINANCE

I N T I L E D

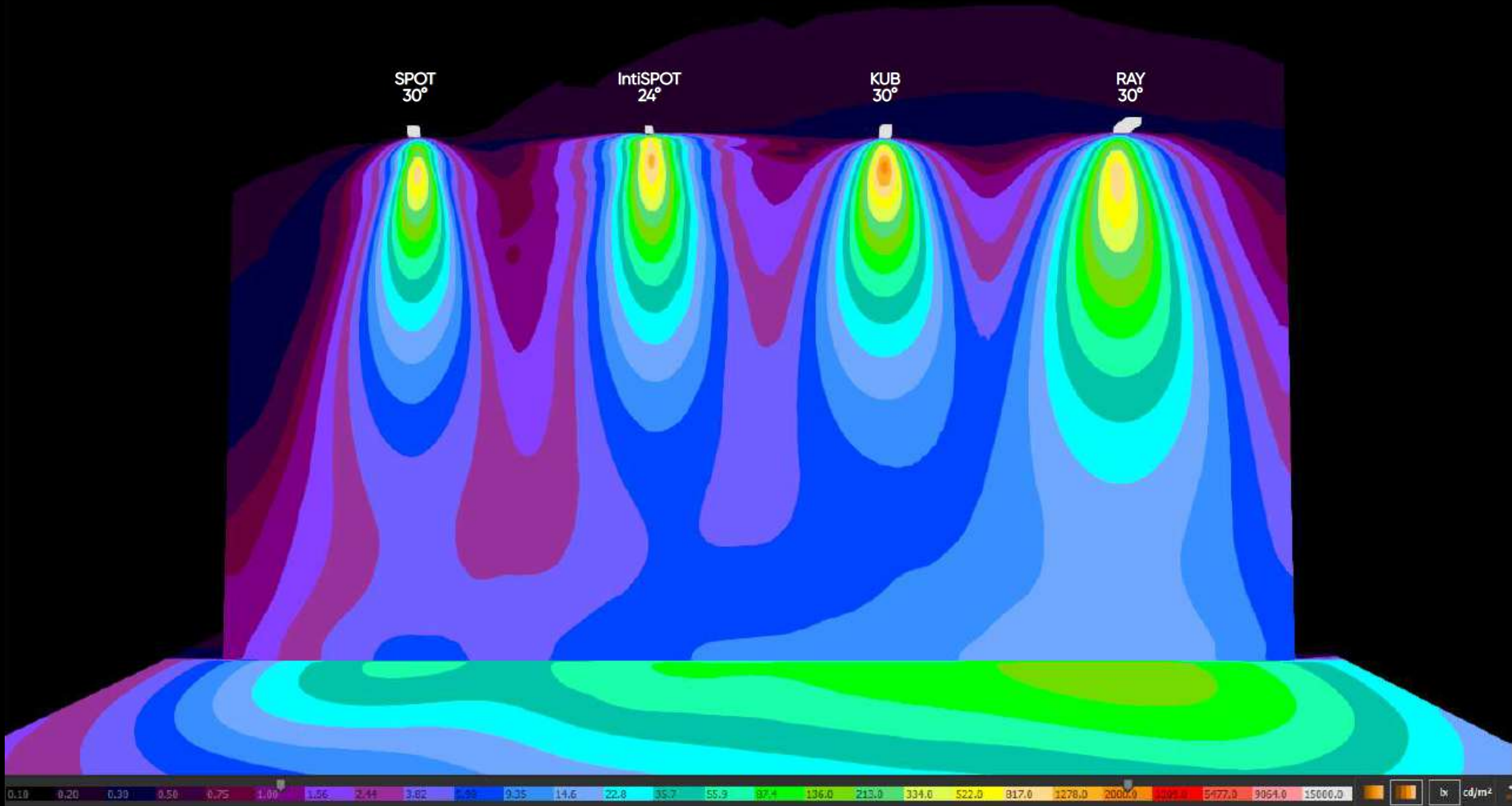

SPOT DIMENSIONAL DRAWING

I N T I L E D

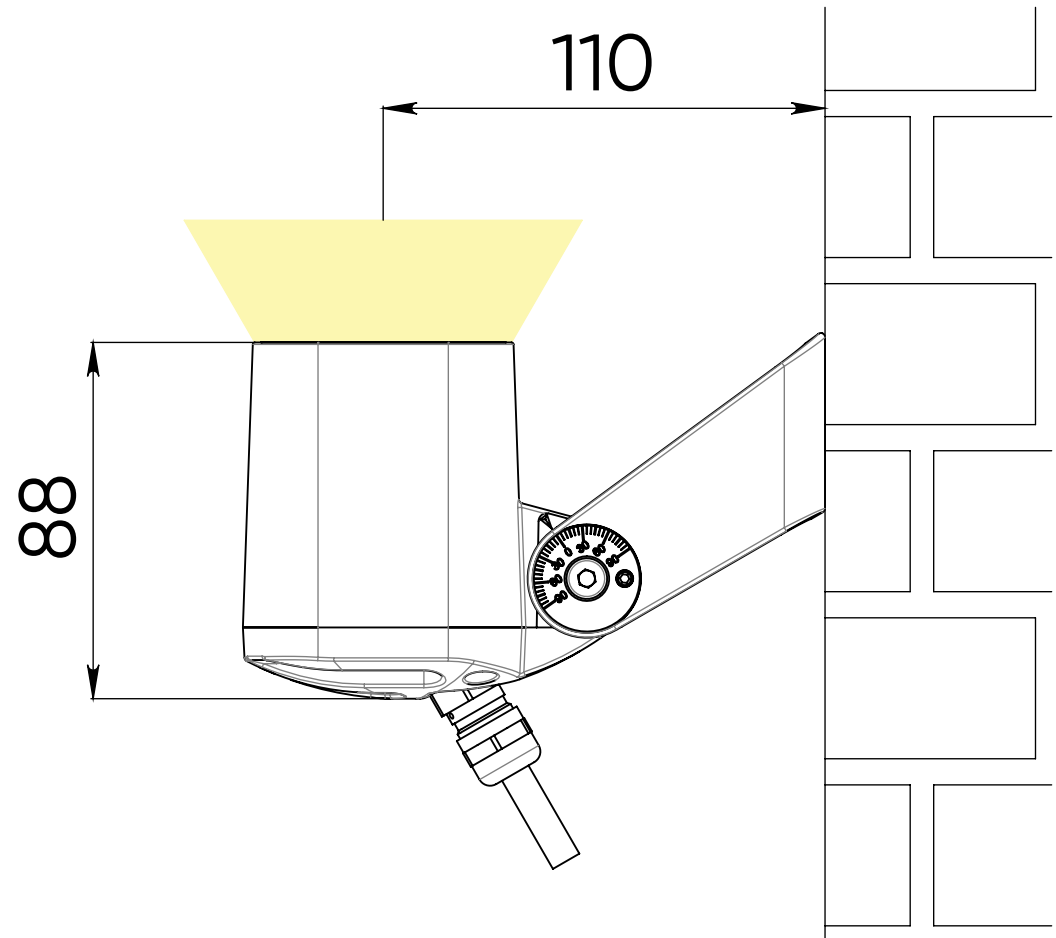
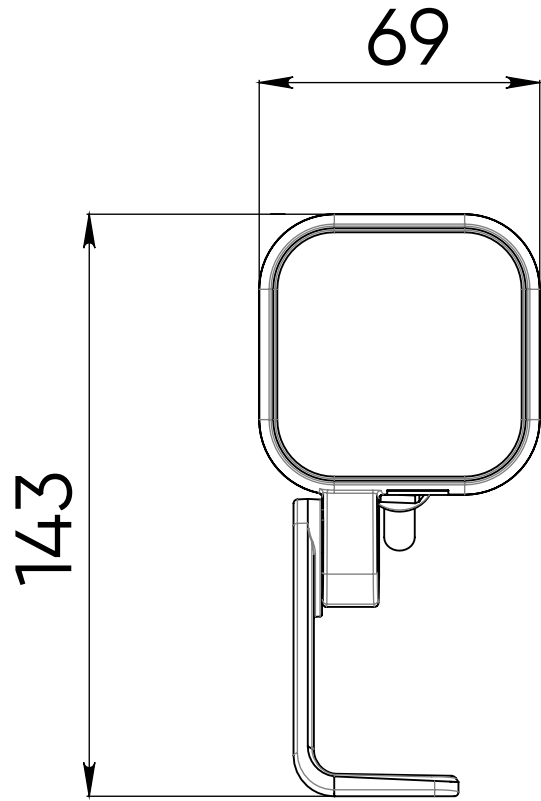

SPOT CONNECTIONS DIAGRAM

I N T I L E D

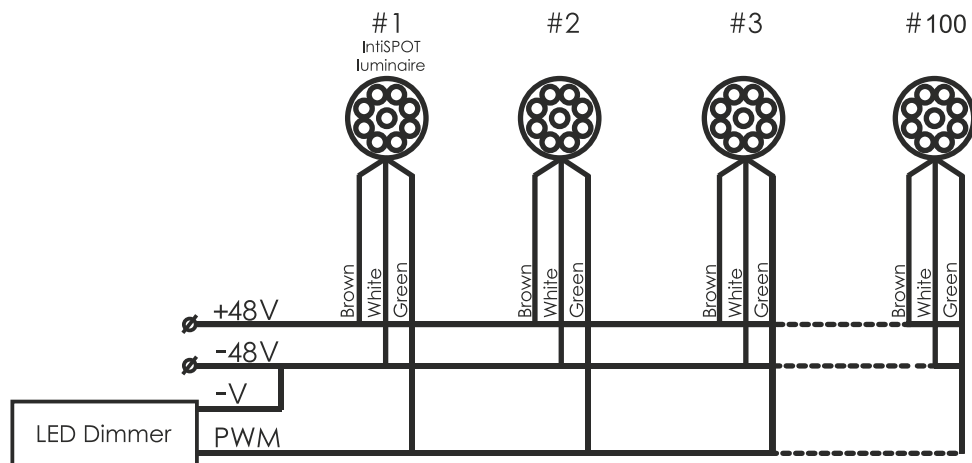

Wire color Input/Output

brown +48 V

white - 48 V

green PWM

Note. If the brightness control "PWM" is not used - green wire is not connected (isolated)

more info

