

# IntiSTARK

Designed for floodlighting. The series includes controllable two-channel spotlights with tunable white, as well as three-, four- and five-channel versions.

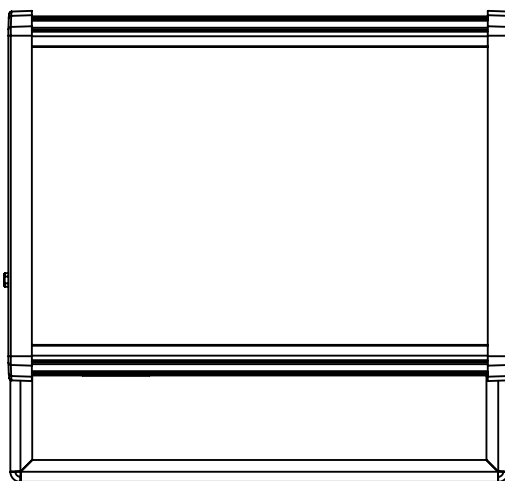

## Application

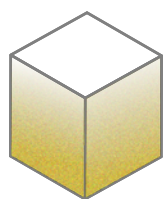

floodlight

# IntiSTARK

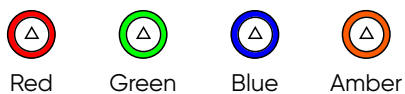
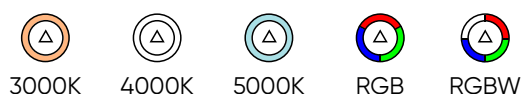

10° 10α30° 10x50°



30° 60° 80°

## CRI

≥80 (for white color)

## Color binning

2 MacAdam ellipses for white,  
±3 nm for color LED

## Power factor

>0,9

## Voltage

230 V AC

## IP66



## Lifespan

not less than 50 000 hours

- 40°C + 55°C

## Controls, protocols

monochrome: not available  
multichannel: DMX-512

## Controls, pixel size

1 luminaire – 1 pixel

## Materials

housing – extruded aluminum section with galvanic coating  
end caps – aluminium alloy  
protective glass – silicate tempered  
brackets – zinc chrome steel, powder-coated  
in the housing color  
support arms – stainless steel

## Standard RAL colors



## Standard coating type

moire

## Accessories

shutters

## Customization

controls for monochrome: DALI, PWM, DMX-512  
connectors IP68  
cable length up to 5m  
voltage: 12, 24, 48 V DC  
optics, light color, wattage and luminous flux customized  
for a specific project

## Available custom versions



## Technologies



### Single housing

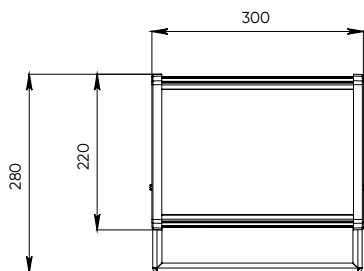

### Dual housing

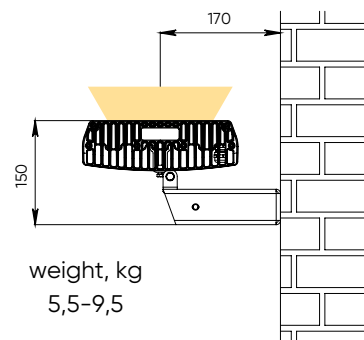
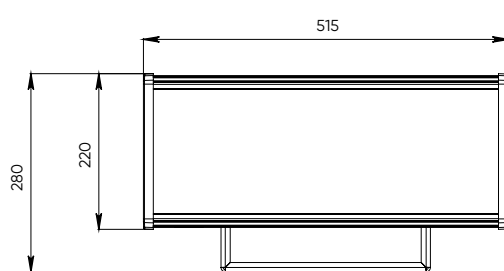

weight, kg  
5,5-9,5

# IntiSTARK

## monochrome

### 1. Select a model

Serial code	Color	W, max	lm, max	weight, kg
IMF24-1	white	25	2400	5,5
	color mono	27	1600	
IMF24-2	white	53	4550	6,5
	color mono	58	2450	
IMF36-2	white	80	6800	6,5
	color mono	87	3650	
IMF72-2	white	160	13500	9,5
	color mono	175	7300	

### 2. Create an article number

Serial code	Color	Optics	Controls	Supply voltage*
IMF24-1	W30 W40 W50 R G B A	10 10α30 10x50 30 60 80	not available	H
IMF24-2				
IMF36-2				
IMF72-2				

\* H – supply voltage 230 V AC

# multichannel

### 1. Select a model

Serial code	Color	W, max	lm, max	weight, kg
IMF36-1	RGB	41	1500	5,5
IMF36-2	RGB	68	2100	6,5
IMF72-2	RGB	135	4200	9,5
IMF49-2	RGBW	25	2000	6,5
IMF98-2	RGBW	50	4000	9,5

### 2. Create an article number

Serial code	Color	Optics	Controls*	Supply voltage**
IMF36-1	RGB	10 10α30 10x50 30 60 80	C	H
IMF36-2				
IMF72-2				
IMF49-2	RGBW30 RGBW40 RGBW50			
IMF98-2				

\* C – protocol DMX-512

\*\*H – supply voltage 230 V AC

### 3. Select accessories

Type*	Article number	Category	Housing	Height, mm	Spacing grid, mm
shutters	PP STARK-01-060-30-30	lateral	single	60	30
	PP STARK-01-060-50-30		dual	60	
	PP STARK-03-030-30-30		single	30	
	PP STARK-03-030-50-30		dual	30	
	PR STARK-01-060-30-30	longitudinal	single	60	
	PR STARK-01-060-50-30		dual	60	

\* shutters – glare protection